

# X442



# Versatex Printbar

A flexible, digital solution to add value,  
**creativity and improve profitability**

# The Xaar Versatex Printbar

Powered by Xaar Nitrox printheads, enables flexible packaging and label integrators and OEMs to upgrade their silk screen printing processes or other analogue methods to a digital inkjet solution. Benefit from Xaar's industry-leading printheads and technologies, as well as the advantages of digital inkjet printing to achieve added value for your application and improve profitability.

## Powered by Xaar Nitrox printheads

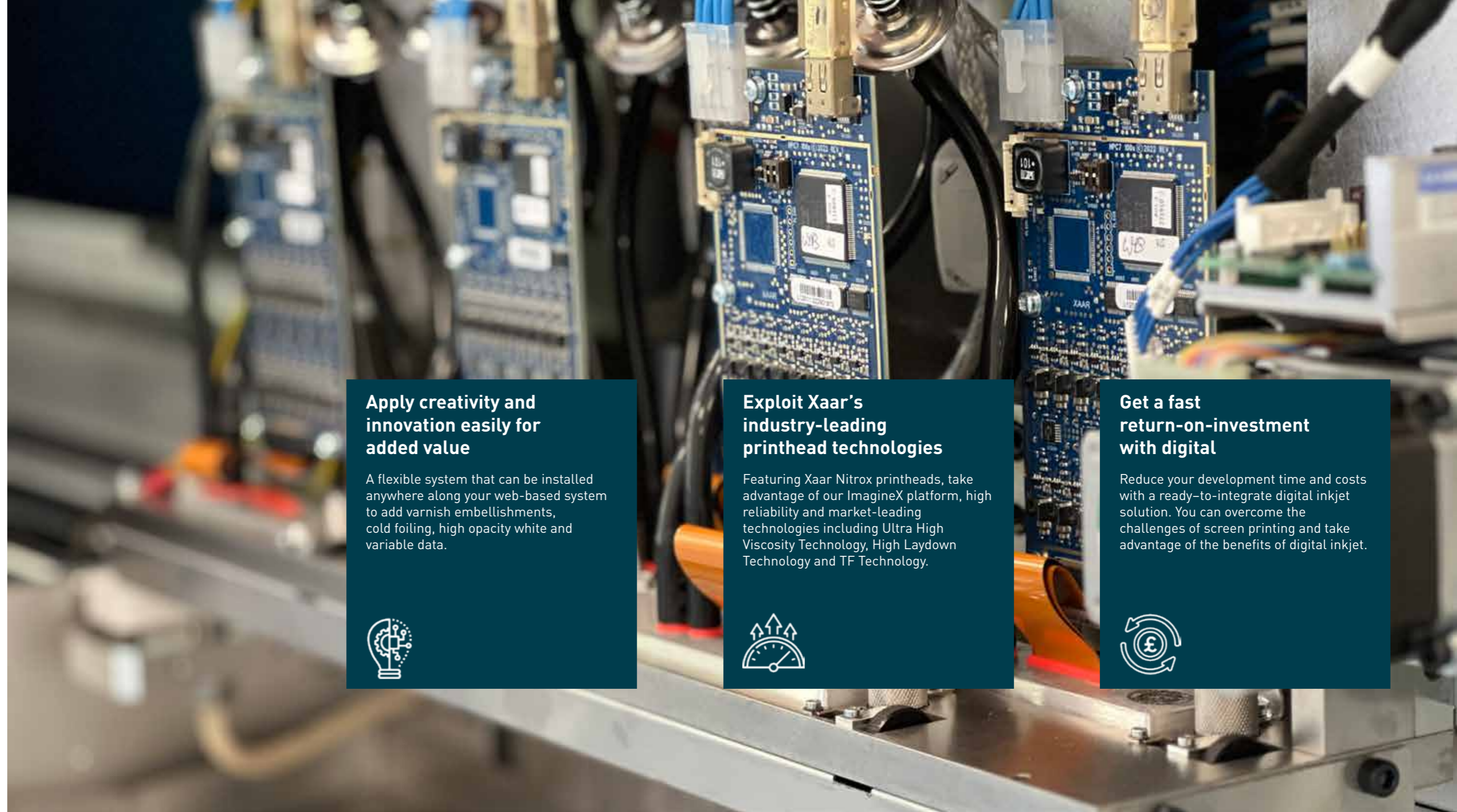

### Apply creativity and innovation easily for added value

A flexible system that can be installed anywhere along your web-based system to add varnish embellishments, cold foiling, high opacity white and variable data.



### Exploit Xaar's industry-leading printhead technologies

Featuring Xaar Nitrox printheads, take advantage of our ImagineX platform, high reliability and market-leading technologies including Ultra High Viscosity Technology, High Laydown Technology and TF Technology.



### Get a fast return-on-investment with digital

Reduce your development time and costs with a ready-to-integrate digital inkjet solution. You can overcome the challenges of screen printing and take advantage of the benefits of digital inkjet.



# Applications

- High opacity white
- Spot varnish
- High build varnish
- Matt varnish
- Textures with specialist substrate replacement
- Digital cold foiling
- Mass customisation
- Variable data

# Achieve a screen like opacity with digital inkjet

Xaar's Ultra High Viscosity Technology breaks new ground – enabling printing up to 1000cP\* and also a significantly higher particulate loading of up to 40%.

With this capability, you can achieve a high opacity of 85% at 50 metres per minute for the most brilliant whites.

Using high viscosity fluids you can improve the efficiency of your process and add more functionality as well as improved benefits to the end use application.

## Integrator advantages that can reduce process time and energy costs:

- Shorter exposure time
- Reduced dot gain
- Less penetration
- Reduced pinning requirements

## End use advantages that can improve durability of the print:

- Higher scratch resistance and toughness
- Increased adhesion
- No yellowing
- Flexibility
- Improved colour gamut

\*100cP at jetting temperature

## Print modes

The Versatex printbar comes pre-programmed with two modes useful for printing whites:

### High opacity

Opacity of 85%

Speed up to 50m/min

720\* 1080dpi, 1dpd

### High productivity

Speed up to 75m/min

720\* 720dpi, 1dpd



Scan to learn more about  
Ultra High Viscosity Technology



Ultra High Viscosity  
TECHNOLOGY



Ultra High Viscosity  
TECHNOLOGY



# Produce high build effects more efficiently with High Laydown Technology



Embellishments provide the added value that bring labels to life, creating a premium look and feel. With the Versatex Printbar you can deliver a digital embellishment capability to the label converters that boosts their profit margins and provides a competitive edge when pitching to brand owners.

## The Xaar Versatex includes a number of print modes for adding varnish embellishments:

**High quality** (printing at 50 m/min at approx. 15.5µm)

**High productivity** (printing at 75 m/min at approx. 11.5µm)

**High build** (printing at 25 m/min at approx. 100µm) using Xaar's unique High Laydown Technology

**NEW: High creativity** - Now you can print in **BOTH** High build and standard varnish laydown at the same time, with the same ink. This printing mode delivers more creativity to your premium label within one single print, which saves converters time – no need to print the same item twice to get this dual effect. With this new High creativity mode users can also print gloss and matt on a label design concurrently. (This mode prints 25m/min at approx. 15.5µm and 100µm concurrently).

## Screen-like quality with the flexibility and efficiency of digital

Xaar's High Laydown Technology, with its high discharge rate, delivers very high volumes of fluid in a single pass, enabling high build varnish for a wide array of tactile effects that can be produced more efficiently with inkjet.

The 720dpi high resolution output of Xaar Nitrox printheads provide outstanding print quality on small text, fine details and effects at twice the availability and uptime due to short job changeovers resulting in higher operational availability.

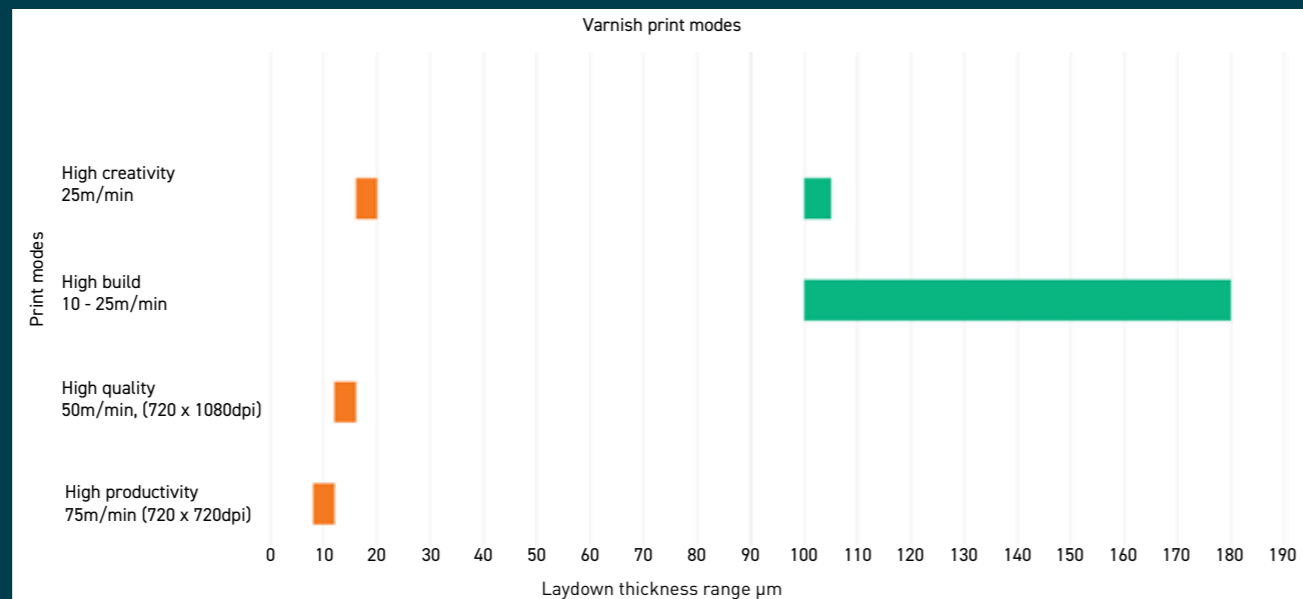

Scan to learn more about High Laydown Technology

# Create a premium look and feel



Before varnish is applied

After varnish is applied



# Taking premium labels to new heights

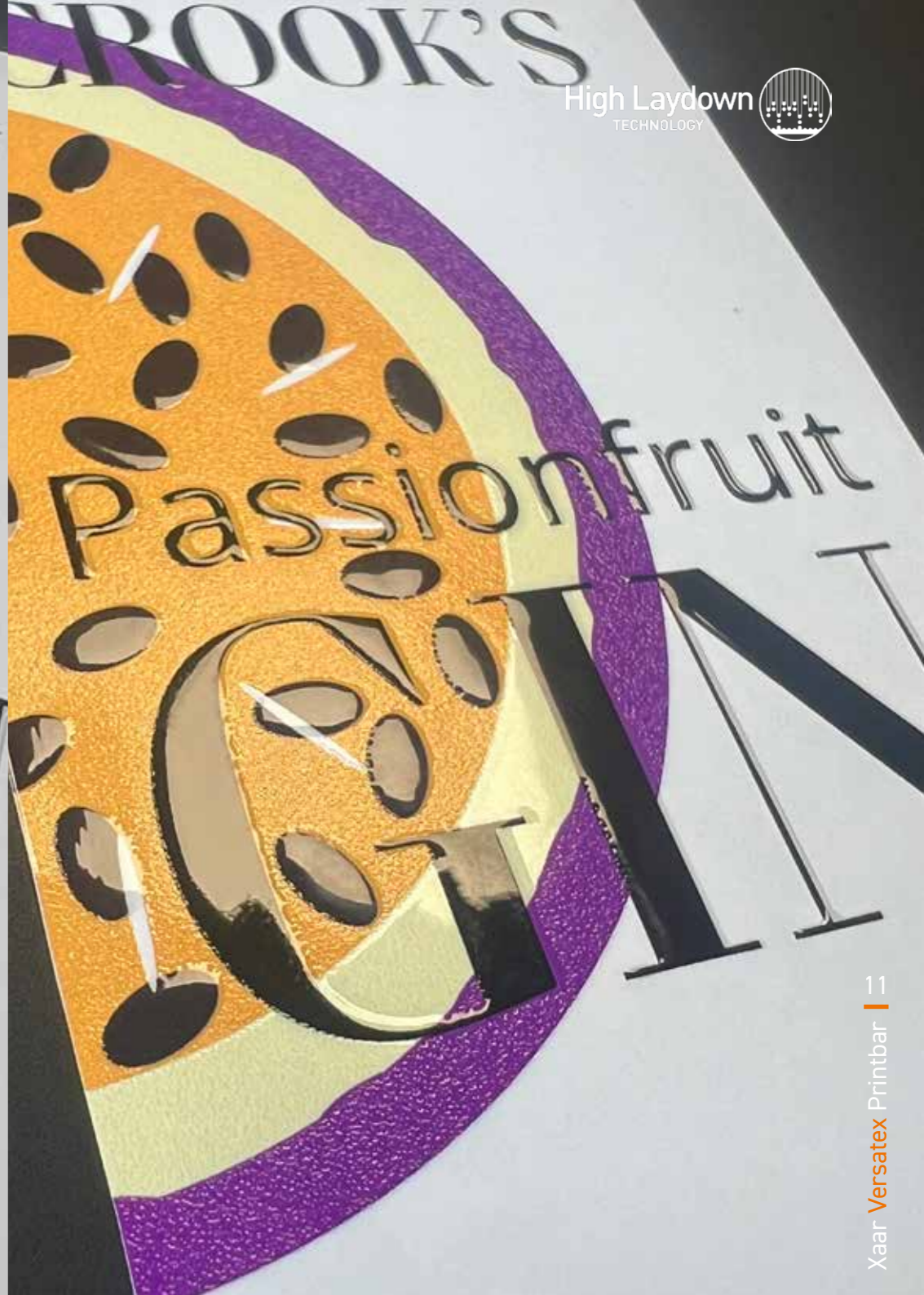
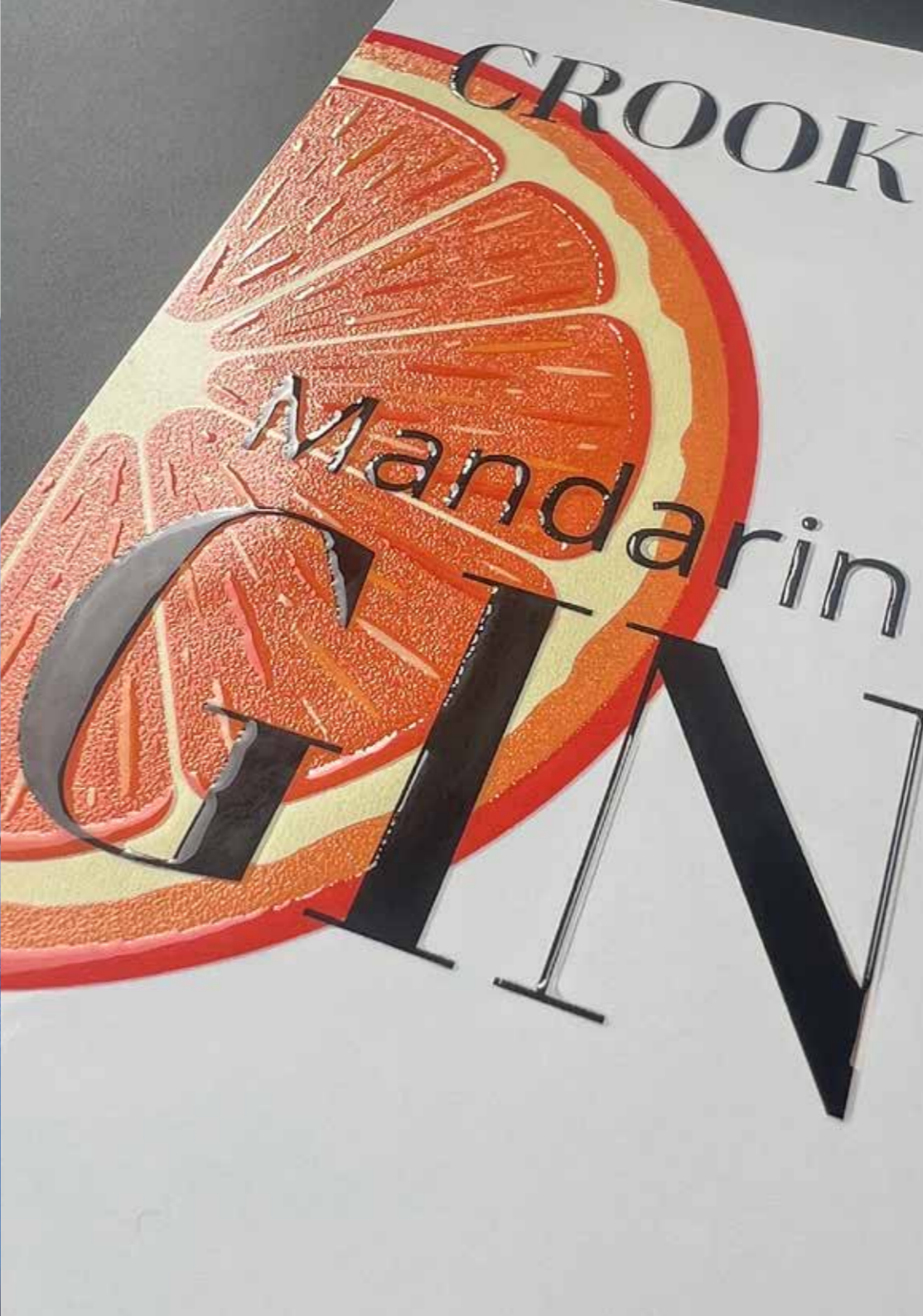
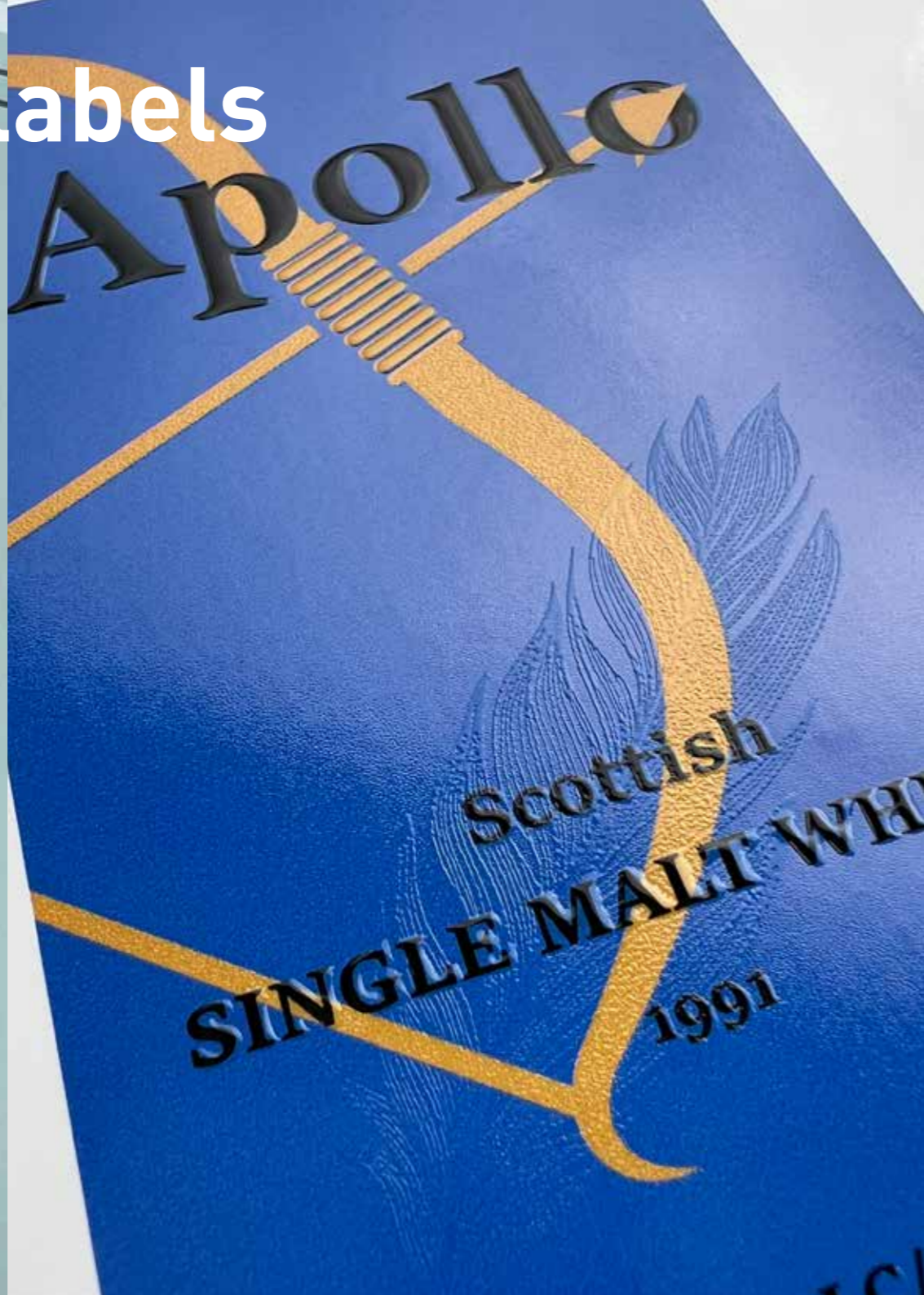

## Use digital cold foiling to your advantage

- Create high-quality, visually appealing effects on premium labels for wine and spirits bottles, cosmetics, perfume and many other products requiring a high-end look
- Use high build digital varnish combined with cold foil for tactile effects on your premium labels
- Use mass-customisation as part of your anti-counterfeiting strategy by creating premium quality short run labels with digital cold foil effects



## Improve profitability with digital

Shorter setup times and a higher utilisation rate of on average 30%, compared to screen printing, can often result in small run jobs being completed before screens are even setup.

	Inkjet	Screen
Number of labels	25,000	25,000
Setup time (mins)	5	40
Media width (mm)	410	410
Print speed (m/min)	75	65
Total job time (mins)	23.5	50
Label size (mm)	100 x 100	100 x 100

### Lower overall cost of production

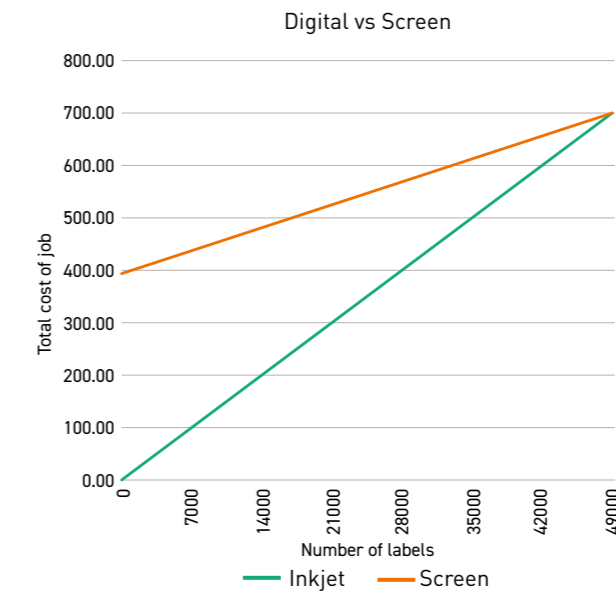
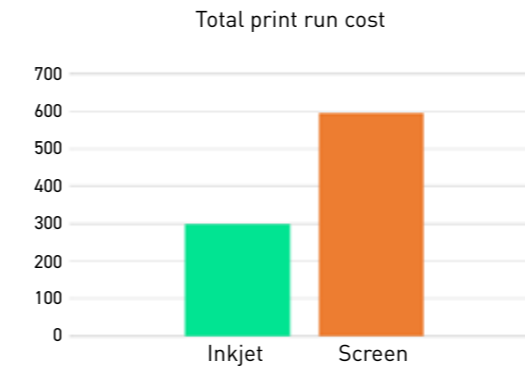

### Increased profit margins on short run jobs

- Lower overall cost of production
- Lower setup costs
- Increased production rates
- Faster make-ready

### Total job time

Compare the total job time of printing 25,000 labels using digital inkjet versus rotary screen.

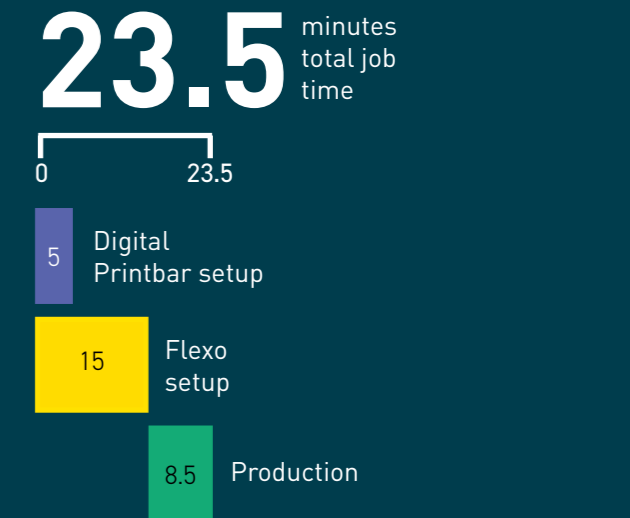
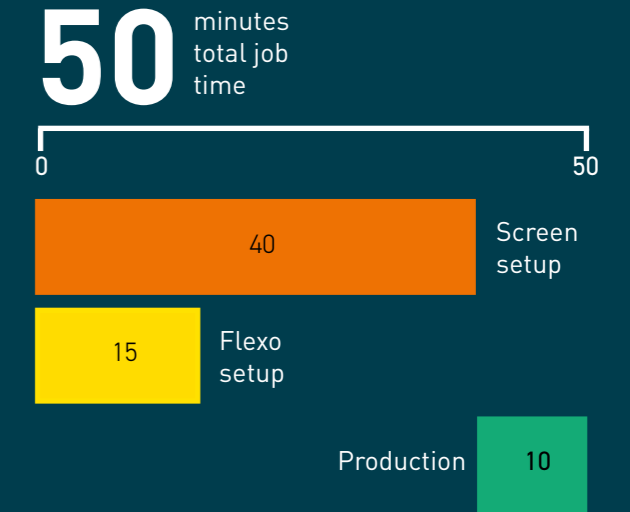

# Take a look inside the Xaar **Versatex** printbar

## 1 Xaar Nitrox printheads



Powered by Xaar Nitrox printheads combining the best of Xaar's technologies to deliver outstanding uniformity, productivity and performance. Printing up to 48kHz\* and delivering speeds of up to 100m/min at 720dpi print resolution, the Nitrox offers speed whilst maintaining perfect uniformity.

\*at 2 grey levels

## 2 Skate & encoder

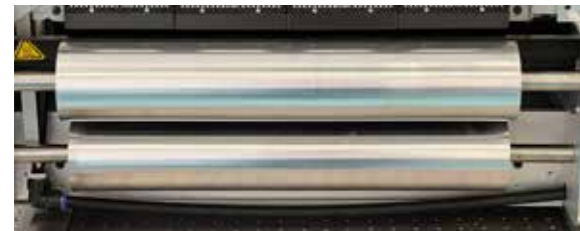

The built-in skate and encoder ensures the highest possible printing accuracy and quality; alongside the substrate handling, this provides precision printing every time. The substrate handling mechanisms, irrespective of the type of press the printbar is mounted on, allows the printbar to accept the substrate and deliver it to the printheads closer than 0.8mm, ensuring maximum drop placement accuracy of the printed dots and a high quality print as standard.

## 3 Sync to mark

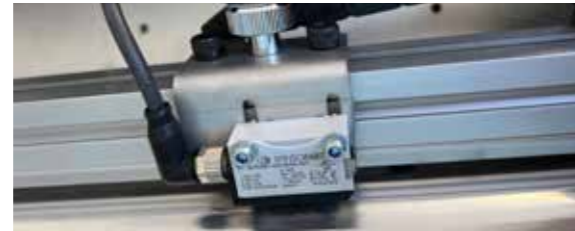

Dynamic synchronisation technology provided within the software/workflow ensures maximum uptime and quick registration with pre-printed substrates. A sync to mark reader built into the product can be moved into any position across the web to read marks, and once running can be in full registration within three to four image repeats.

## 4 LED pinning & mist extraction



Integrated LED pinning offers users maximum flexibility for the final cure where required for the desired application. The power of pinning can also be fully controlled offering even more flexibility. A vacuum is included to extract any ink mist associated with printing, improving print quality by removing unwanted ink particles before they contaminate the substrate.

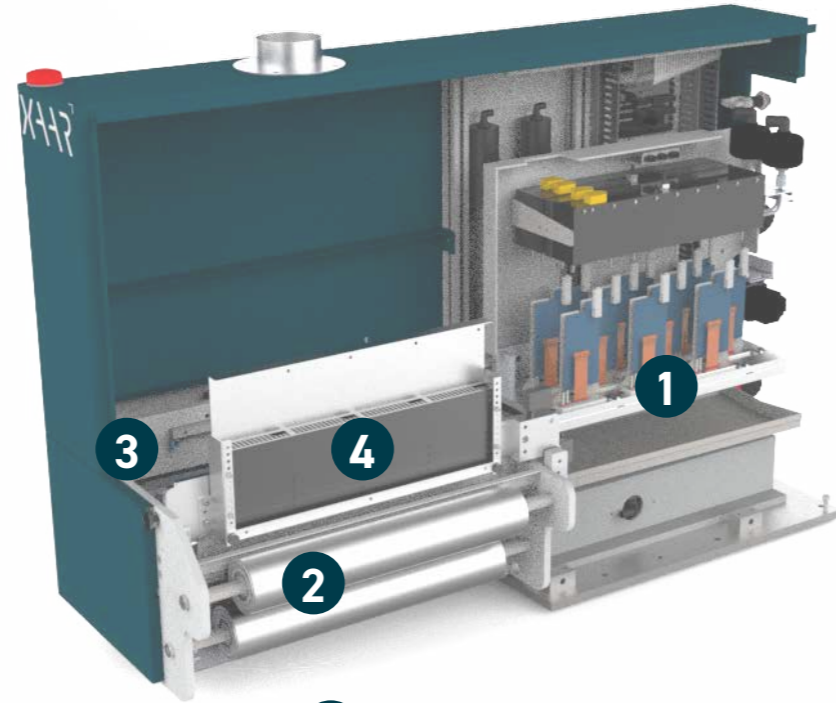

## Ink supply system

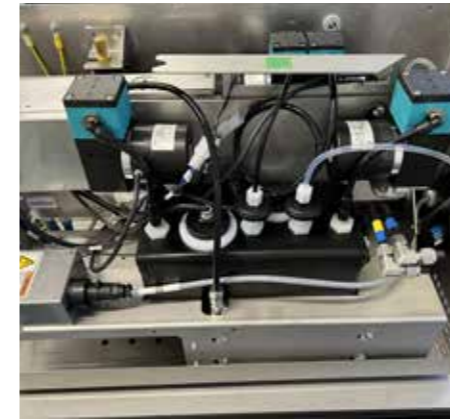

Our high flow recirculating ink supply system with exact temperature control and precise nozzle meniscus pressure control (ink flow rate) ensures optimal jetting operation.

## Control cabinet



The Versatex Printbar includes a fully integrated and flexible control cabinet that houses all the necessary electronics and controls to drive the printbar and can be easily moved up to five metres away from the printbar.

## Maintenance



Versatex Printbars are fitted with a fully integrated maintenance station to ensure maximum uptime and lowest possible "make ready" time. As standard the Printbar has an auto maintenance module that applies suction to each printhead between job printing and with no manual intervention from the operator. The recirculating ink system can also be left in standby mode in any printing breaks, to enable agility and flexibility within shifts.

## Support



Whilst the Xaar Versatex Printbar has been designed for low maintenance and easy servicing, full technical support and service offers you peace of mind for when you do need assistance. Take advantage of our hands-on, practical training which can be on-site or at Xaar, technical manuals and documentation provided in a variety of output formats and languages, an online knowledge base, spare parts support, emergency breakdown servicing and remote technical assistance, including remote connection to equipment.

# Ready-to-integrate solution to get to market quickly

Take advantage of proven ready to market inkjet technology without the development overheads. Integrate seamlessly onto new configurations or retrofit onto existing installs at any point on the press.

## Printing press

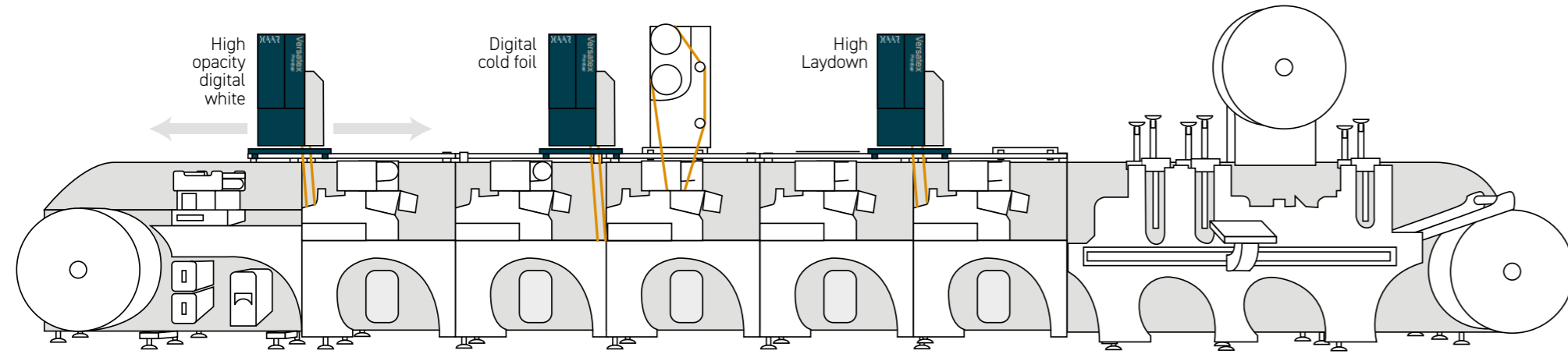

## Finishing line

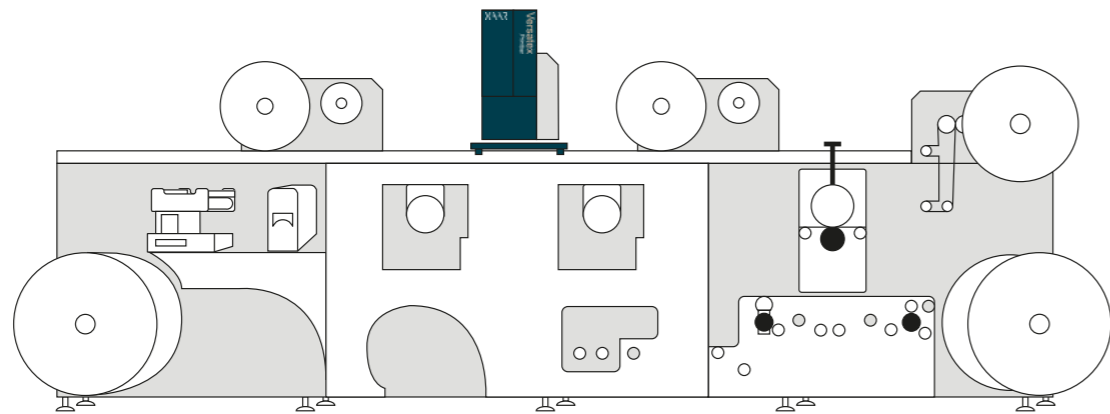

# TF Technology fluid recirculation delivers unrivalled reliability

TF Technology fluid recirculation with a very high flow rate keeps the fluid in constant motion at all times, ensuring the pigment does not settle.

The fluid directly passes the back of the nozzle and in the nozzle itself, to keep the printhead continuously primed and preventing any sedimentation or blocked nozzles.

Any air bubbles and unwanted particles in the fluid are carried away, radically improving reliability, even in the harshest industrial environment.

Heat is removed by the recirculating fluid, reducing temperature variation across the printhead virtually eliminating print density variations.



Scan to learn more about TF Technology

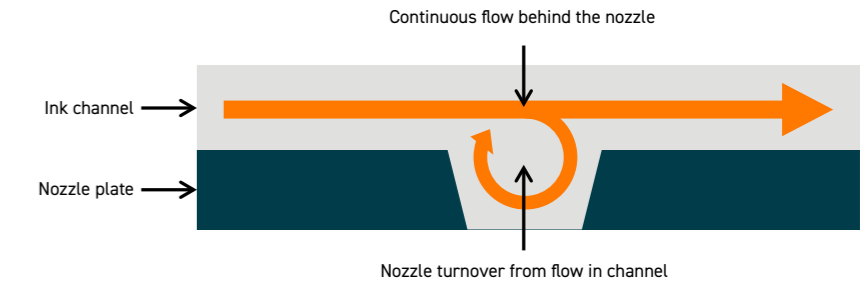

# Minimise maintenance and downtime with Sure Flow self-cleaning mode

With Xaar's TF Technology ink recirculation, a regularly maintained printhead is extremely unlikely to block. However, external factors and challenging applications can create exceptionally harsh operational environments for inkjet printing.

Sure Flow enables users to clear and prevent nozzle blockages without the need to remove the printhead, maximising operational print time for optimum productivity.

Enabled by software, users simply activate the mode from the GUI. This drives each channel to work at maximum power and frequency to create ultrasonic waves that produce controlled vibrations of the channel walls without pausing production.



Scan to learn more about Sure Flow







## Key features

Speed	Up to 100m/min
Print width	Up to 410mm
Media width	Up to 430mm
DPI/print quality	720dpi
Available fluids	UV curable CMYK, high opacity fluids, black, varnish, spot colours & low migration
Substrates	
Type	Optimised for coated/ uncoated paper, supported/unsupported film (PP, PE, PET) and foil
Minimum thickness	40µm
Maximum thickness	250µm
HMI/DFE	TIFF catcher DFE workflow and jobs database. Suitable for integration to wide variety of digital workflow systems including Esko Automation engine

## Print modes

<b>Varnish print modes</b>	
High quality	50m/min at 15.5µm
High productivity	75m/min at 11.5µm
High build	25m/min at 100µm
High creativity	25m/min, 15.5µm to 100µm concurrently
<b>High opacity (white) print modes</b>	
High opacity	Opacity of 85%, speed up to 50m/min 720 x 1080dpi, 1dpd
High productivity	Speed up to 75m/min 720 x 720dpi, 1dpd



Scan to learn more at Xaar.com

Head Office / Europe  
+ 44 1223 423 663  
info@xaar.com

Asia  
+ 86 755 23309293  
info@xaar.com

USA  
americas@xaar.com